



Scheda Tecnica - Technical Sheet

Adattatore semplice

Simple adapter plug



Art.
300611B
300611N

**Adattatore Schuko
semplice
2P+T 16A~ 250V
Schuko 2P+T
16A~ 250V**



Dimensioni: 43x43xh70 mm
Size:

**Spina 2P+T 16A~ 250V
Presca Schuko 2P+T
16A~ 250V**
*Plug 2P+T 16A~ 250V
Socket Schuko 2P+T 16 A~ 250V*

Colori: Bianco - Nero
Colours: White - Black

**Corpo in polimero
Potenza max 1500W
Spinotti in ottone nichelato
Prese grado prot. 2.1**
*Polymer body
Max power 1500W
Nickel-plated brass pins
Sockets with protection 2.1*



Certificazione IMQ

**NORME: CEI 23-50
CEI 23-57**



Packaging

Art. 300611

Scatolo con stampa in quadricromia
Giftbox 4 colours

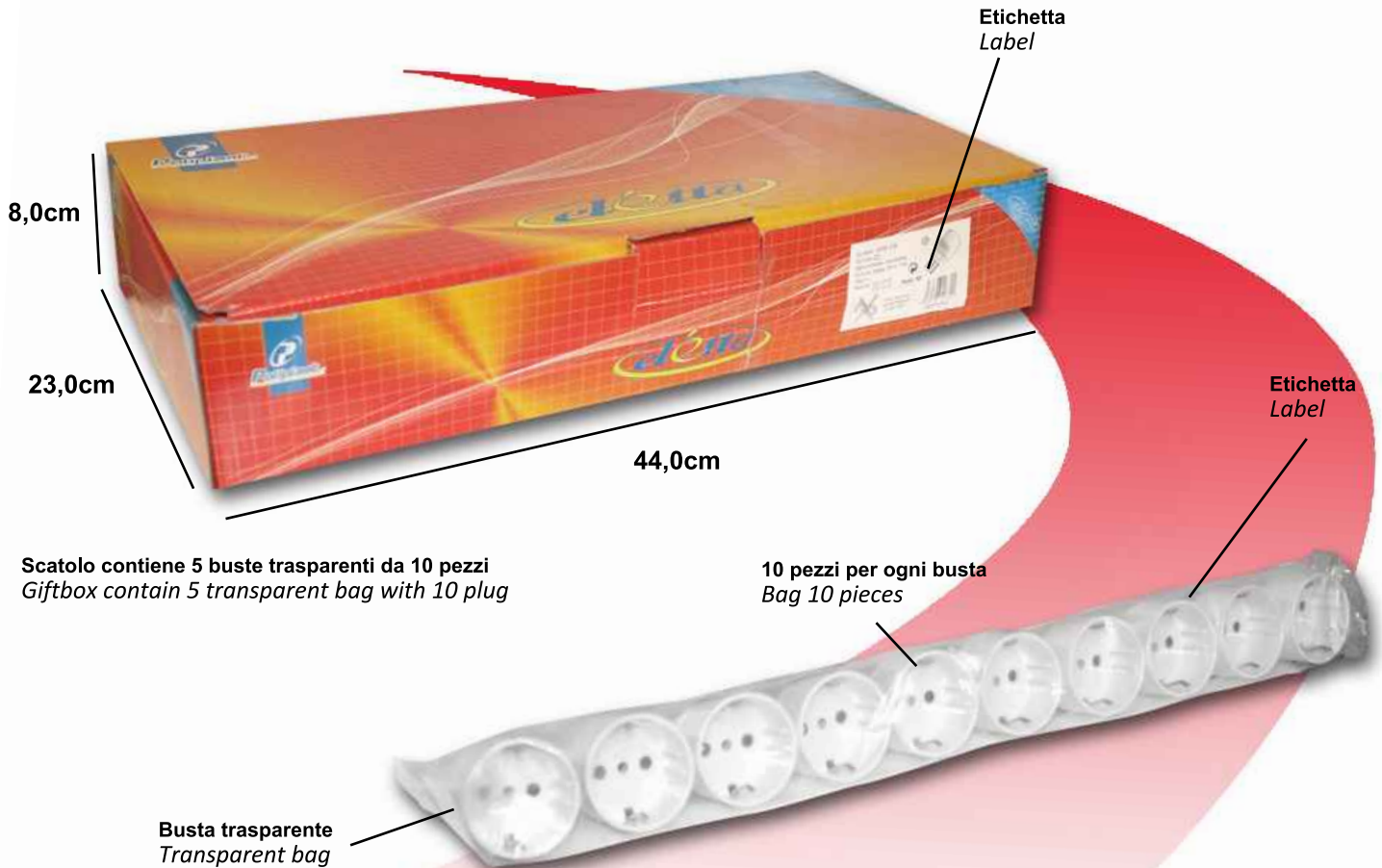

Export Carton/PCS

Bar Code:
Position 4 sides
in the upper left



Lateral Sides
Shipping Mark:

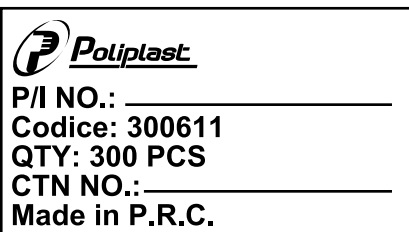

Central Sides
Shipping Mark:

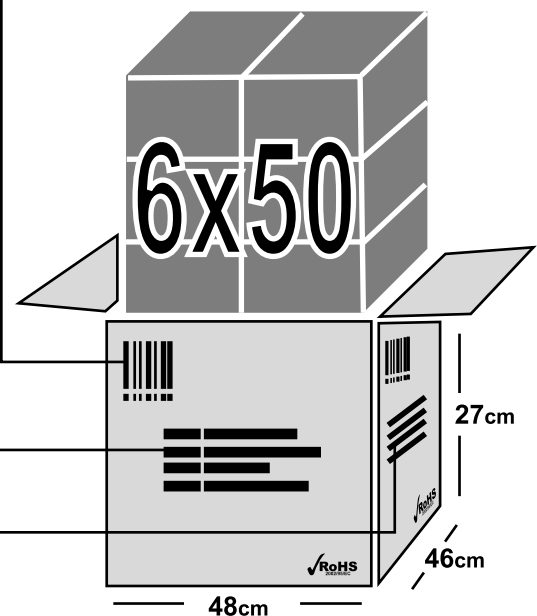
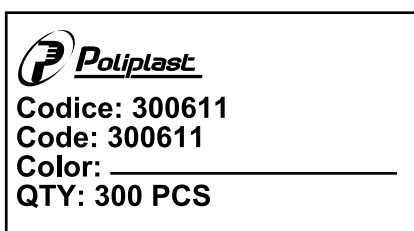

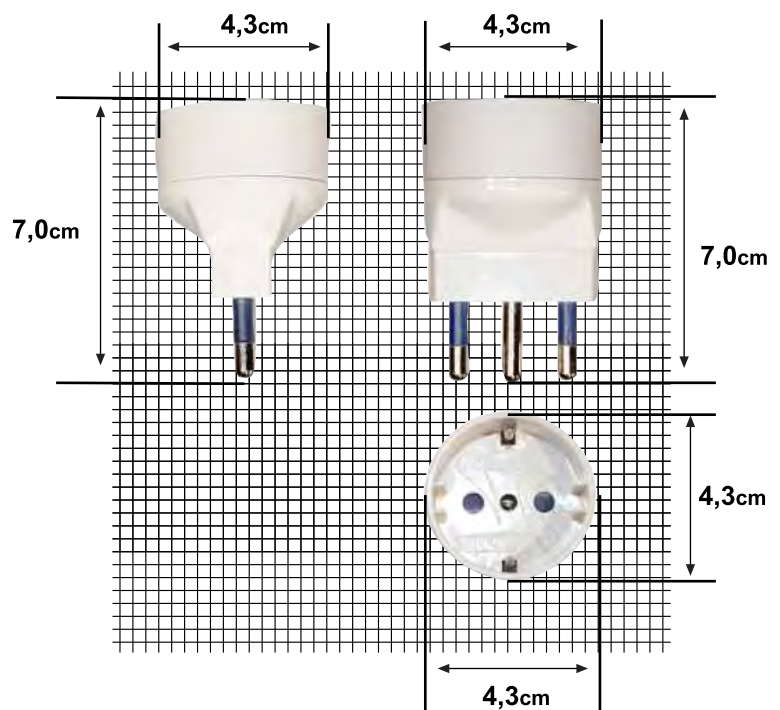

Art. 300611N
70x50 mm
Etichetta per lo scatolo
Label for box

Codice: 300611N
 Colore: ■
 Descrizione: Adattatore Schuko
 Spina 2P+T 16A 250V~
 Norme: CEI 23-50
 CEI 23-57 **Pezzi: 50**



Non inserire
un adattatore
in un altro



8 032706 127424
Made in P.C.R.

Art. 300611B
70x50 mm
Etichetta per lo scatolo
Label for box

Codice: 300611B
 Colore: □
 Descrizione: Adattatore Schuko
 Spina 2P+T 16A 250V~
 Norme: CEI 23-50
 CEI 23-57 **Pezzi: 50**





Non inserire
un adattatore
in un altro



8 032706 127417
Made in P.C.R.

elètta **Poliplast**

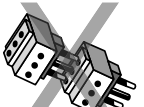
Codice: 300611N
 Colore: Nero
 Descrizione: Adattatore Schuko
 Spina 2P+T 16A 250V~
 Norme: CEI 23-50
 CEI 23-57

Non inserire
un adattatore
in un altro

Pezzi: 10
Made in P.C.R.



8 032706 127424

85x40 mm
Etichetta per la busta
Label for bag

elètta **Poliplast**

Codice: 300611B
 Colore: Bianco
 Descrizione: Adattatore Schuko
 Spina 2P+T 16A 250V~
 Norme: CEI 23-50
 CEI 23-57

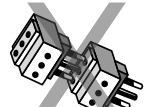
Non inserire
un adattatore
in un altro

Pezzi: 10
Made in P.C.R.



8 032706 127417

85x40 mm
Etichetta per la busta
Label for bag



IMQ S.p.A. Società a Socio Unico
I-20138 Milano - via Quintiliano, 43
tel. 0250731(r.a.) - fax 0250991500
e-mail: info@imq.it - www.imq.it

Rea Milano 1595884
Registro Imprese MI 12898410159
C.F./P.I. 12898410159
Capitale Sociale € 4.000.000

CA02.03813
SN.J000D5

PID:
02114000
CID:
CN.F00089

Certificato di approvazione

Approval certificate

IMQ, ente di certificazione accreditato, *IMQ, accredited certification body, grants to*
autorizza la ditta

POLIPLAST SRL
ZONA INDUSTRIALE 13esima STRADA N. 34-36
95121 CATANIA CT

all'uso del marchio

the licence to use the mark

IMQ

Il presente certificato è soggetto alle condizioni previste nel Regolamento "MARCHI IMQ - Regolamento per la certificazione di prodotti" ed è relativo ai prodotti descritti nell'Allegato al presente certificato.



per i seguenti prodotti

for the following products

Adattatori per uso domestico
(Rif. di tipo 300611)

Adaptors for domestic purposes
(Type ref. 300611)

This certificate is subjected to the conditions foreseen by Rules "IMQ MARKS - RULES for product certification" and is relevant to the products listed in the annex to this certificate.

Emesso il | Issued on **2009-04-22**
Aggiornato il | Updated on **2014-10-20**
Sostituisce | Replaces **2010-02-16**

IMQ S.p.A.

